

Data Sheet



Article number: 204280M1260A1S

Description: E+G levelling foot

GN 42-80-M12-60-A1-S

Note: S Without nut, External hexagon at the bottom

Measures

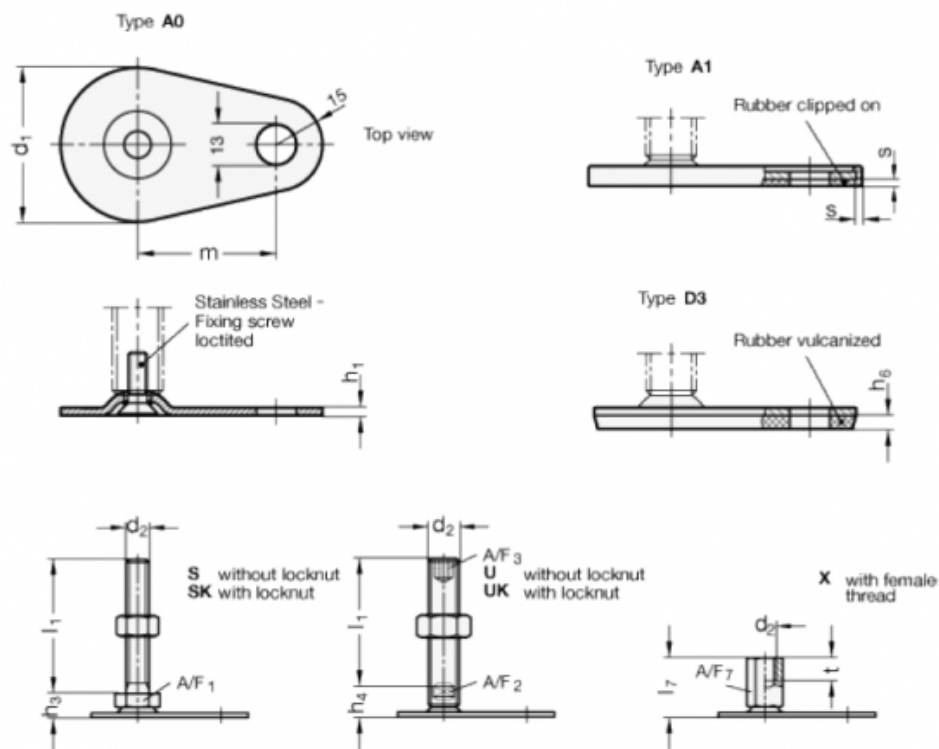

A/F1 = 17	s = 2
d1 = 80	
d2 = M12	
h1 = 3	
h3 = 12	
h6 =	
l1 = 60	
m = 70	